

SMD Power Inductor CDRH10D48/A



Description

- Ferrite drum core construction.
- Magnetically shielded.
- L × W × H: 10.5 × 10.5 × 5.0 mm Max.
- Product weight: 1.8 g(Ref.)
- Moisture Sensitivity Level: 1
- RoHS compliance.
- Qualification to AEC-Q200.

Environmental Data

- Operating temperature range: -40°C ~ +125°C (including coil's self temperature rise)
- Storage temperature range: -40°C ~ +85°C
- Solder reflow temperature: 260 °C peak.

Packaging

- Carrier tape and reel packaging.
- 11.8" diameter reel
- 500pcs per reel

Applications

- Automotive and other high temperature, high reliability application.

Dimension - [mm]

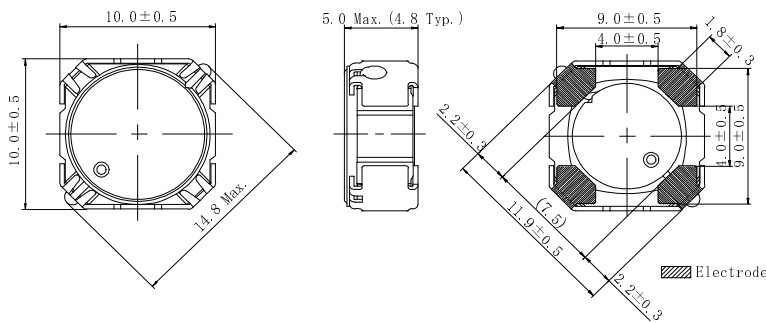

Land pattern and Schematics - [mm]

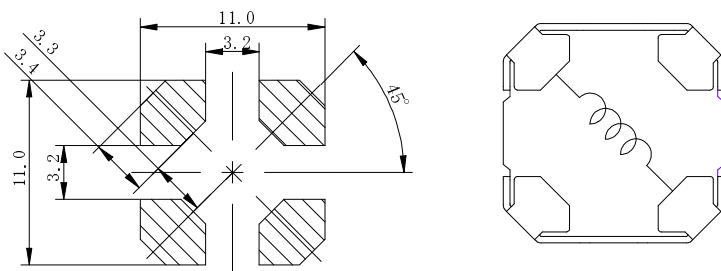

SMD Power Inductor

CDRH10D48/A



Electrical Characteristics

Part No.	Stamp	Inductance [μ H] [within] ※1	D.C.R. (m Ω) [Max.] (Typ.) (at 20°C)	Rated current (A) ※2
CDRH10D48/ANP-2R4MC	2R4	2.4 μ H \pm 20%	12(9)	5.2
CDRH10D48/ANP-3R4MC	3R4	3.4 μ H \pm 20%	13(10)	4.8
CDRH10D48/ANP-4R3MC	4R3	4.3 μ H \pm 20%	15(12)	4.3
CDRH10D48/ANP-5R8MC	5R8	5.8 μ H \pm 20%	24(19)	3.8
CDRH10D48/ANP-7R2MC	7R2	7.2 μ H \pm 20%	29(23)	2.9
CDRH10D48/ANP-8R7MC	8R7	8.7 μ H \pm 20%	37(29)	2.7
CDRH10D48/ANP-100MC	100	10 μ H \pm 20%	40(32)	2.6
CDRH10D48/ANP-120MC	120	12 μ H \pm 20%	44(35)	2.5
CDRH10D48/ANP-150MC	150	15 μ H \pm 20%	49(39)	2.3
CDRH10D48/ANP-180MC	180	18 μ H \pm 20%	62(49)	2.2
CDRH10D48/ANP-220MC	220	22 μ H \pm 20%	70(56)	1.9
CDRH10D48/ANP-270MC	270	27 μ H \pm 20%	90(72)	1.7
CDRH10D48/ANP-330MC	330	33 μ H \pm 20%	113(90)	1.5
CDRH10D48/ANP-390MC	390	39 μ H \pm 20%	127(101)	1.4
CDRH10D48/ANP-470MC	470	47 μ H \pm 20%	138(110)	1.3
CDRH10D48/ANP-560MC	560	56 μ H \pm 20%	172(137)	1.2
CDRH10D48/ANP-680MC	680	68 μ H \pm 20%	209(167)	1.1
CDRH10D48/ANP-820MC	820	82 μ H \pm 20%	268(214)	0.97
CDRH10D48/ANP-101MC	101	100 μ H \pm 20%	294(235)	0.92
CDRH10D48/ANP-121MC	121	120 μ H \pm 20%	374(299)	0.82
CDRH10D48/ANP-151MC	151	150 μ H \pm 20%	437(349)	0.77
CDRH10D48/ANP-181MC	181	180 μ H \pm 20%	558(446)	0.65
CDRH10D48/ANP-221MC	221	220 μ H \pm 20%	637(509)	0.61
CDRH10D48/ANP-271MC	271	270 μ H \pm 20%	839(671)	0.53
CDRH10D48/ANP-331MC	331	330 μ H \pm 20%	938(750)	0.49

※1. Measuring condition: at 100 kHz.

※2. The value of current when the inductance decrease to 65% of it's nominal value or DC current when $\Delta T=30^{\circ}\text{C}$ whichever is lower. ($T_a=125^{\circ}\text{C}$)

SMD Power Inductor CDRH10D48/A



Saturation Current & Temperature Rise Graph

— L (20°C) — L (125°C) — ΔT

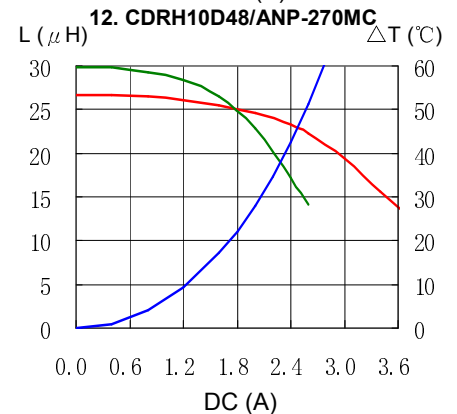
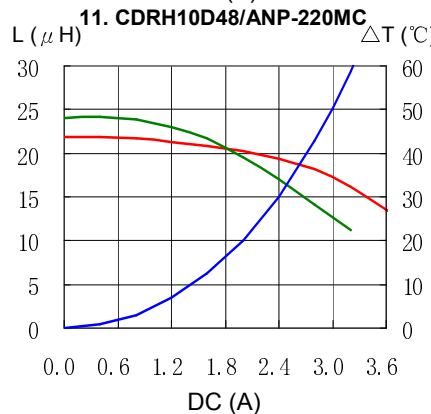
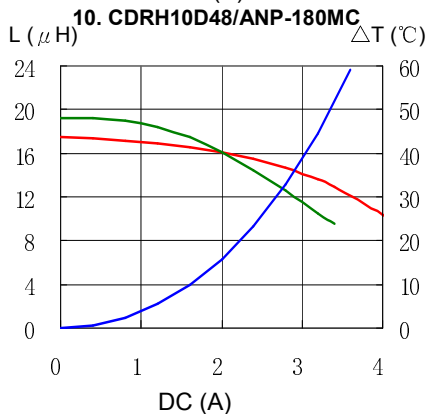
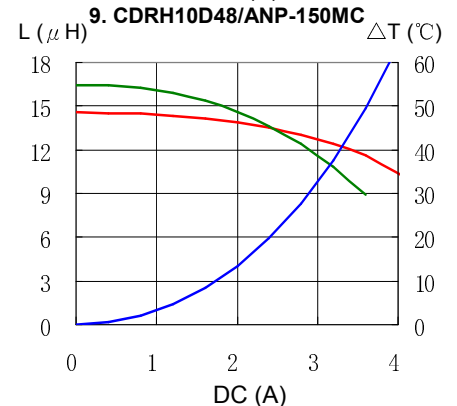
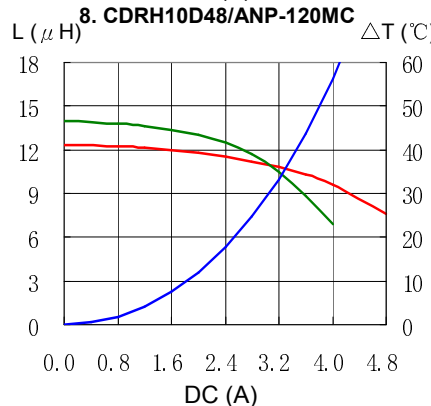
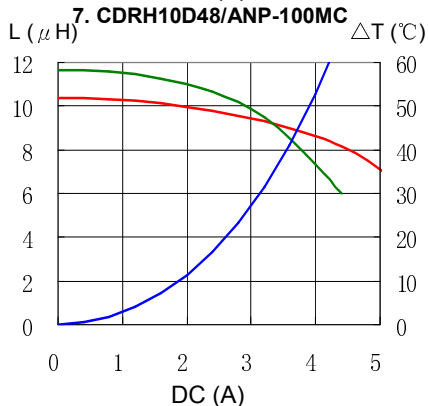
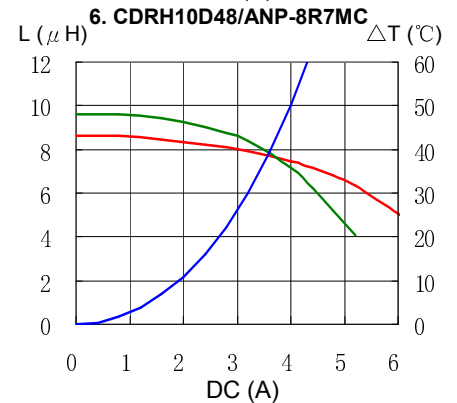
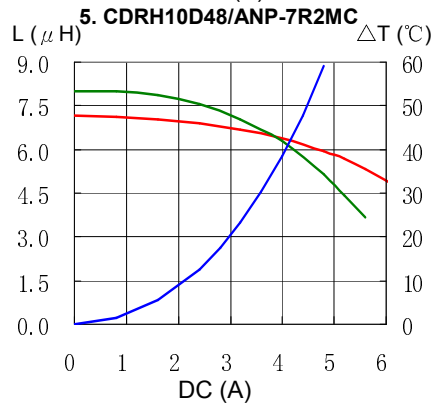
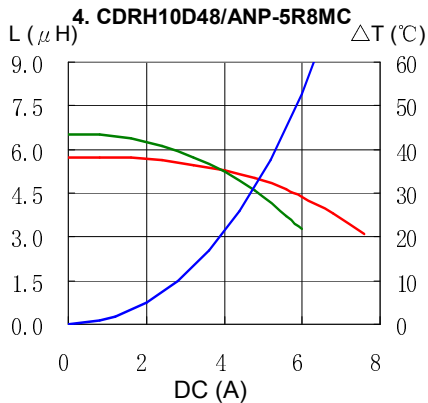
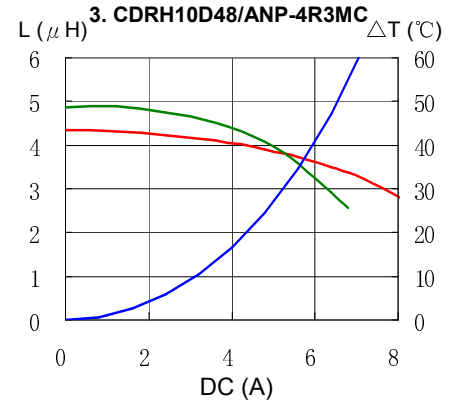
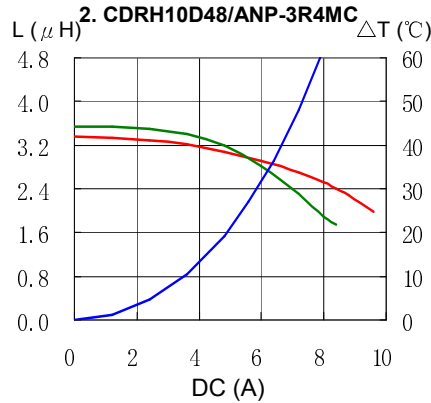
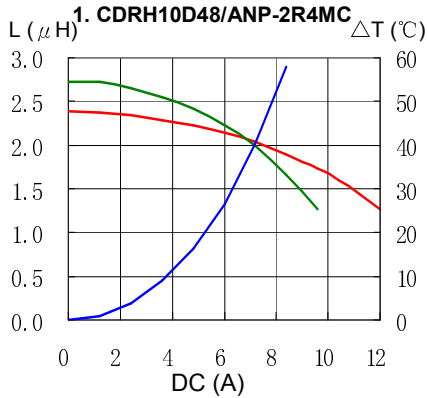

SMD Power Inductor CDRH10D48/A



Saturation Current & Temperature Rise Graph

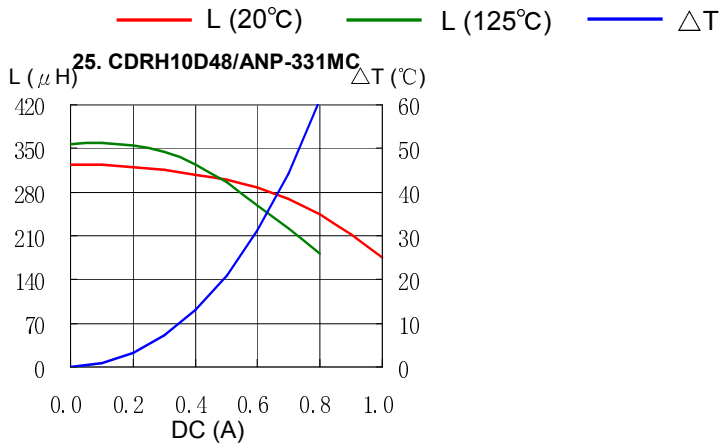

Solder Reflow Condition

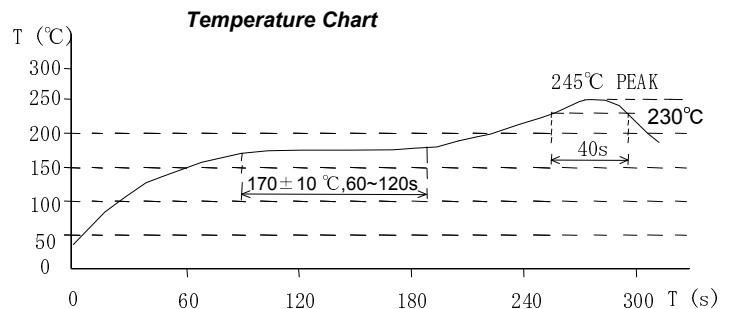
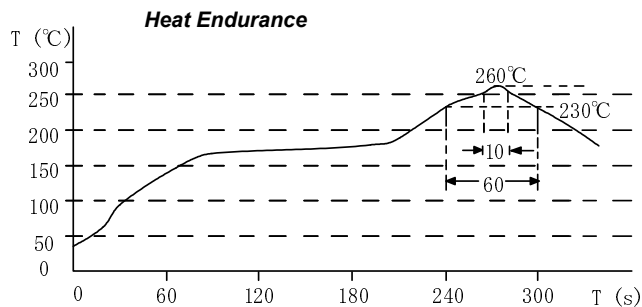

Please refer to the sales offices on our website - <http://www.sumida.com>

Hong Kong

Tel.+852-2880-6781
FAX.+852-2565-9600
sales@hk.sumida.com

Saitama(Japan)

Tel.+81-48-691-7300
FAX.+81-48-691-7340
sales@jp.sumida.com

Chicago

Tel.+1-847-545-6700
FAX. +1-847-545-6720
sales@us.sumida.com

Shanghai

Tel.+86-21-5836-3299
FAX.+86-21-5836-3266
shanghai.sales@cn.sumida.com

Seoul

Tel.+82-2-6237-0777
FAX.+82-2-6237-0778
sales@kr.sumida.com

Oberzell

Tel.+49-8591-937-0
FAX. +49-8591-937-103
contact@eu.sumida.com

Shenzhen

Tel.+86-755-8291-0228
FAX.+86-755-8291-0338
shenzhen.sales@cn.sumida.com

Singapore

Tel.+65-6296-3388
FAX.+65-6841-4426
sales@sg.sumida.com

Neumarkt

Tel.+49-9181-4509-110
FAX. +49-9181-4509-310
infocomp@eu.sumida.com

Taipei

Tel.+886-2-8751-2737
FAX.+886-2-8751-2738
sales@tw.sumida.com

San Jose

Tel.+1-408-321-9660
FAX.+1-408-321-9308
sales@us.sumida.com

Mouser Electronics

Authorized Distributor

Click to View Pricing, Inventory, Delivery & Lifecycle Information:

Sumida:

[CDRH10D48/ANP-4R3MC](#) [CDRH10D48/ANP-7R2MC](#) [CDRH10D48/ANP-100MC](#) [CDRH10D48/ANP-220MC](#)
[CDRH10D48/ANP-820MC](#) [CDRH10D48/ANP-120MC](#) [CDRH10D48/ANP-2R4MC](#) [CDRH10D48/ANP-271MC](#)
[CDRH10D48/ANP-151MC](#) [CDRH10D48/ANP-5R8MC](#) [CDRH10D48/ANP-680MC](#) [CDRH10D48/ANP-390MC](#)
[CDRH10D48/ANP-121MC](#) [CDRH10D48/ANP-330MC](#) [CDRH10D48/ANP-560MC](#) [CDRH10D48/ANP-270MC](#)
[CDRH10D48/ANP-150MC](#) [CDRH10D48/ANP-470MC](#) [CDRH10D48/ANP-3R4MC](#) [CDRH10D48/ANP-331MC](#)
[CDRH10D48/ANP-180MC](#) [CDRH10D48/ANP-221MC](#) [CDRH10D48/ANP-8R7MC](#) [CDRH10D48/ANP-181MC](#)
[CDRH10D48/ANP-101MC](#)