

BIPOLAR ANALOG INTEGRATED CIRCUIT
 μ PC1688G

5 V, 1.1 GHz WIDE BAND AND FLAT GAIN AMPLIFIER SILICON MMIC

DESCRIPTION

The μ PC1688G is a silicon monolithic integrated circuit especially designed as a flat gain and wide band amplifier covering HF through UHF band.

FEATURES

- Flat gain: $\Delta G_P = \pm 1$ dB_{TYP.} @ $f = 0.1$ to 0.7 GHz
- Frequency response : 1.1 GHz_{TYP.} @ 3dB band width
- Power gain : 21 dB_{TYP.} @ 0.5 GHz
- Supply voltage : 5 V \pm 0.5 V
- 4 pin mini mold package

ORDERING INFORMATION

Order Number	Package	Marking	Supplying Form	
μ PC1688G	4 pin mini mold	C1C	Plastic magazine case	
μ PC1688G-T1			• Embossed tape 8 mm wide.	Tape perforation side faces pin3, 4.
μ PC1688G-T2			• QTY 3 kpcs/Reel.	Tape perforation side faces pin1, 2.

Remarks To order evaluation samples, please contact your local NEC sales office.

INTERNAL EQUIVALENT CIRCUIT

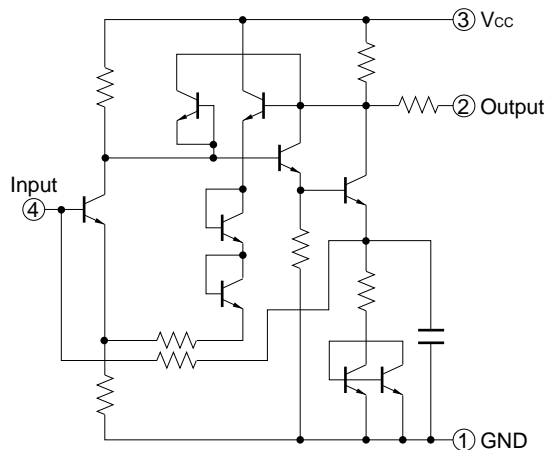

PIN CONNECTIONS
(Top View)

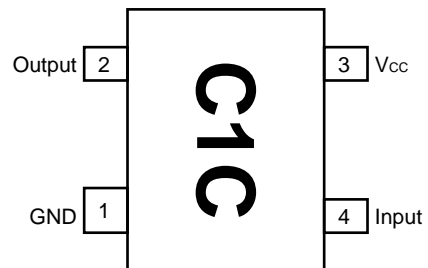

Caution Electro-static sensitive devices

ABSOLUTE MAXIMUM RATINGS (T_A = +25 °C)

Supply Voltage	V _{CC}	6	V
Input Power	P _{in}	+10	dBm
Total Power Dissipation	P _T	200	mW
Operating Temperature	T _{opt}	-40 to +85	°C
Storage Temperature	T _{stg}	-55 to +150	°C

ELECTRICAL CHARACTERISTICS (T_A = +25 °C, V_{CC} = 5 V, Z_s = Z_L = 50 Ω)

Characteristic	Symbol	MIN.	TYP.	MAX.	Unit	Test Conditions
Circuit current	I _{CC}	14	19	24	mA	No input signal
Power gain	G _P	18	21	23	dB	f = 0.5 GHz (G _P = S ₂₁)
Noise figure	NF	—	4.0	5.5	dB	f = 0.5 GHz
Upper limit operating frequency	f _u	0.9	1.1	—	GHz	3 dB down below 0.1 GHz gain
Isolation	ISL	23	27	—	dB	f = 0.5 GHz (ISL = S ₁₂)
Input return loss	RL _{in}	10	13	—	dB	f = 0.5 GHz (RL _{in} = S ₁₁)
Output return loss	RL _{out}	10	13	—	dB	f = 0.5 GHz (RL _{out} = S ₂₂)
Maximum output level	P _{O(sat)}	2	4	—	dBm	f = 0.5 GHz, P _{in} = -5 dBm

As for test circuit and application circuit, please refer to Application note (Document No. 10964EJ2V0AN00).

TYPICAL CHARACTERISTICS ($T_A = 25\text{ }^\circ\text{C}$, Unless otherwise specified)

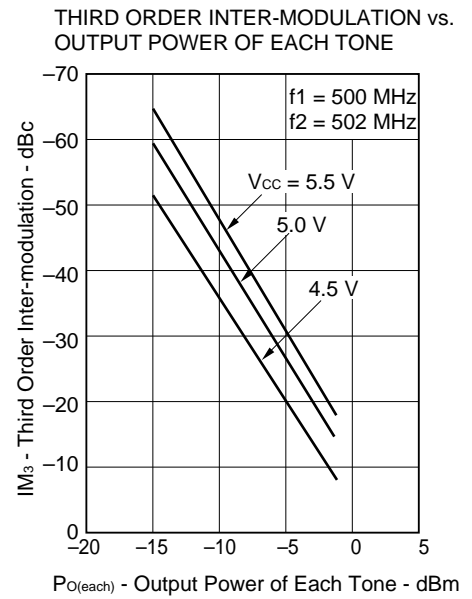
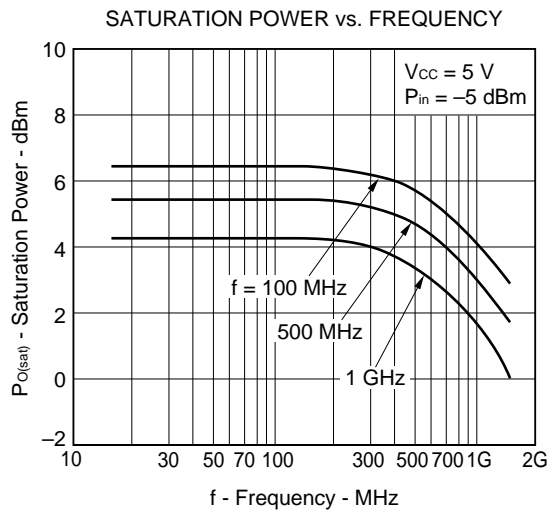
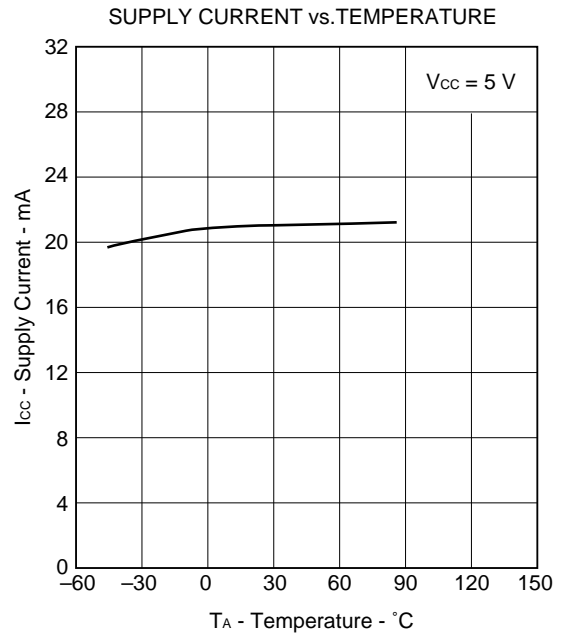
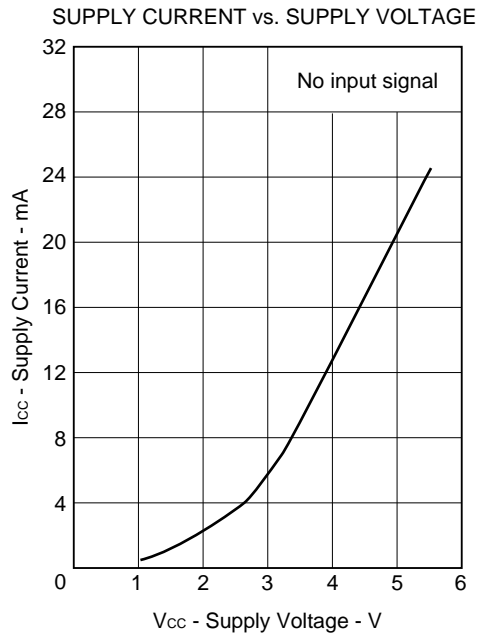

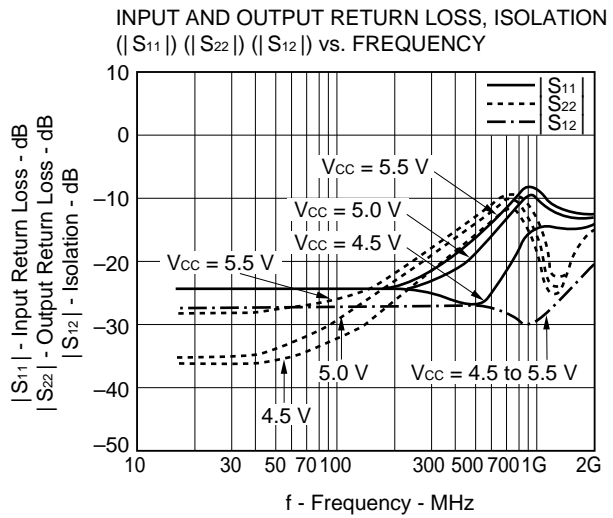
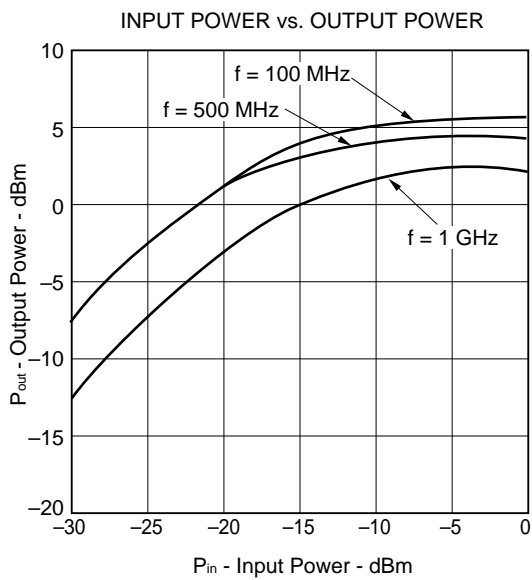
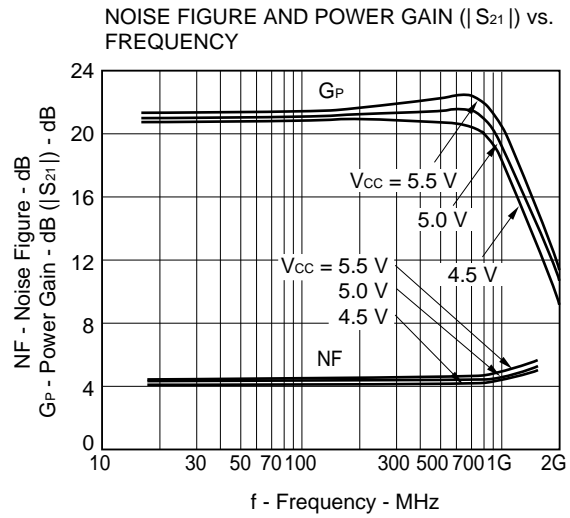
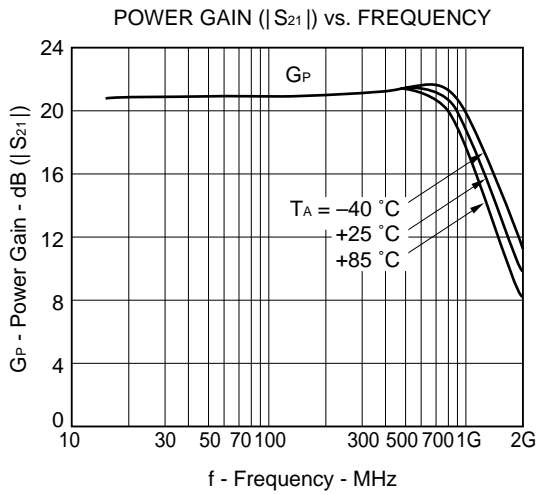

PACKAGE DIMENSIONS (Unit: mm)

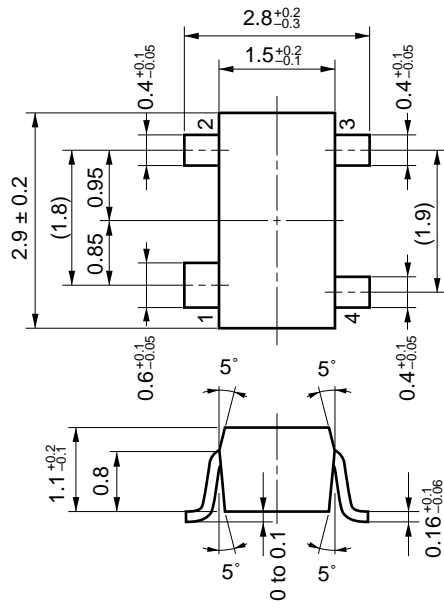

NOTE ON CORRECT USE

- (1) Observe precautions for handling because of electro-static sensitive devices.
- (2) Form a ground pattern as wide as possible to minimize ground impedance (to prevent undesired oscillation).
- (3) Keep the track length of the ground pins as short as possible.
- (4) The bypass capacitor should be attached to the Vcc pin.
- (5) The DC cut capacitor must be each attached to the input and output pins.

RECOMMENDED SOLDERING CONDITIONS

This product should be soldered in the following recommended conditions. Other soldering methods and conditions than the recommended conditions are to be consulted with our sales representatives.

μPC1688G

Soldering Method	Soldering Conditions	Recommended Condition Symbol
Infrared ray reflow	Package peak temperature: 235 °C, Hour: within 30 s. (more than 210 °C), Time: 3 times, Limited days: no. Note	IR35-00-3
VPS	Package peak temperature: 215 °C, Hour: within 40 s. (more than 200 °C), Time: 3 times, Limited days: no. Note	VP15-00-3
Wave soldering	Soldering tub temperature: less than 260 °C, Hour: within 10 s. Time: Limited days: no. Note	WS60-00-1
Pin part heating	Pin area temperature: less than 300 °C, Hour: within 3 s/pin. Limited days: no. Note	

Note It is the storage days after opening a dry pack, the storage conditions are 25 °C, less than 65 % RH.

Caution The combined use of soldering method is to be avoided (However, except the pin area heating method).

For details of recommended soldering conditions for surface mounting, refer to information document **SEMICONDUCTOR DEVICE MOUNTING TECHNOLOGY MANUAL (C10535EJ7V0IF00)**.

[MEMO]

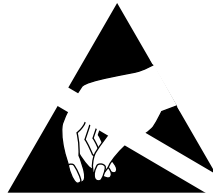

ATTENTION

OBSERVE PRECAUTIONS
FOR HANDLING
ELECTROSTATIC
SENSITIVE
DEVICES

No part of this document may be copied or reproduced in any form or by any means without the prior written consent of NEC Corporation. NEC Corporation assumes no responsibility for any errors which may appear in this document.

NEC Corporation does not assume any liability for infringement of patents, copyrights or other intellectual property rights of third parties by or arising from use of a device described herein or any other liability arising from use of such device. No license, either express, implied or otherwise, is granted under any patents, copyrights or other intellectual property rights of NEC Corporation or others.

While NEC Corporation has been making continuous effort to enhance the reliability of its semiconductor devices, the possibility of defects cannot be eliminated entirely. To minimize risks of damage or injury to persons or property arising from a defect in an NEC semiconductor device, customer must incorporate sufficient safety measures in its design, such as redundancy, fire-containment, and anti-failure features.

NEC devices are classified into the following three quality grades:

"Standard", "Special", and "Specific". The Specific quality grade applies only to devices developed based on a customer designated "quality assurance program" for a specific application. The recommended applications of a device depend on its quality grade, as indicated below. Customers must check the quality grade of each device before using it in a particular application.

Standard: Computers, office equipment, communications equipment, test and measurement equipment, audio and visual equipment, home electronic appliances, machine tools, personal electronic equipment and industrial robots

Special: Transportation equipment (automobiles, trains, ships, etc.), traffic control systems, anti-disaster systems, anti-crime systems, safety equipment and medical equipment (not specifically designed for life support)

Specific: Aircrafts, aerospace equipment, submersible repeaters, nuclear reactor control systems, life support systems or medical equipment for life support, etc.

The quality grade of NEC devices in "Standard" unless otherwise specified in NEC's Data Sheets or Data Books. If customers intend to use NEC devices for applications other than those specified for Standard quality grade, they should contact NEC Sales Representative in advance.

Anti-radioactive design is not implemented in this product.