

YG901C2R

LLD (200V / 5A TO-220F15)

LOW LOSS SUPER HIGH SPEED DIODE

Features

- Low V_F
- Super high speed switching.
- High reliability by planer design.

Applications

- High speed power switching.

Maximum Ratings and Characteristics

- Absolute Maximum Ratings

Item	Symbol	Conditions	Rating	Unit
Repetitive peak reverse voltage	V_{RRM}		200	V
Repetitive peak surge reverse voltage	V_{RSM}		200	V
Isolation voltage	V_{iso}	Terminals to Case, AC, 1min.	1500	V
Average output current	I_o	duty=1/2, $T_c=120^\circ\text{C}$ Square wave	5*	A
Surge current	I_{FSM}	Sine wave 10ms	25	A
Operating junction temperature	T_j		-40 to +150	$^\circ\text{C}$
Storage temperature	T_{stg}		-40 to +150	$^\circ\text{C}$

* Out put current of centertap full wave connection.

- Electrical Characteristics ($T_a=25^\circ\text{C}$ Unless otherwise specified)

Item	Symbol	Conditions	Max.	Unit
Forward voltage drop **	V_F	$I_F=2.5\text{A}$	0.95	V
Reverse current **	I_R	$V_R=V_{RRM}$	100	μA
Reverse recovery time	t_{rr}	$I_F=0.1\text{A}, I_R=0.2\text{A}, I_{rec}=0.05\text{A}$	35	ns
Thermal resistance	$R_{th(j-c)}$	Junction to case	3.5	$^\circ\text{C/W}$

** Rating per element

- Mechanical Characteristics

Mounting torque	Recommended torque	0.3 to 0.5	N · m
Weight		2.3	g

Outline Drawings

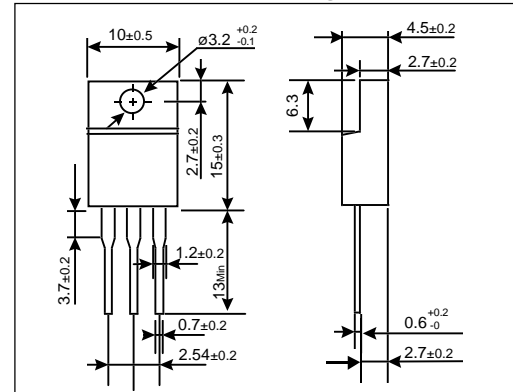

JEDEC

EIAJ

SC-67

Connection Diagram

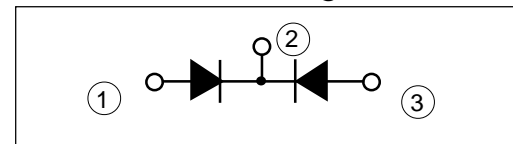

■ Characteristics

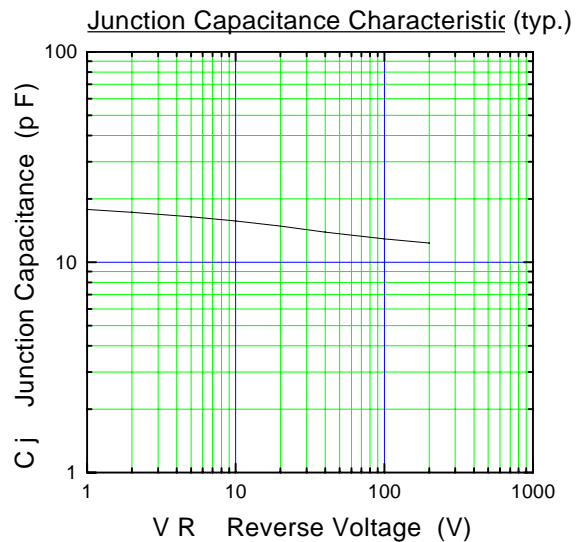
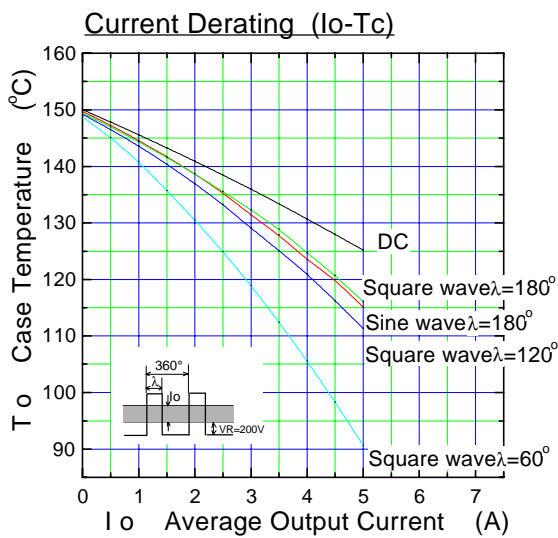
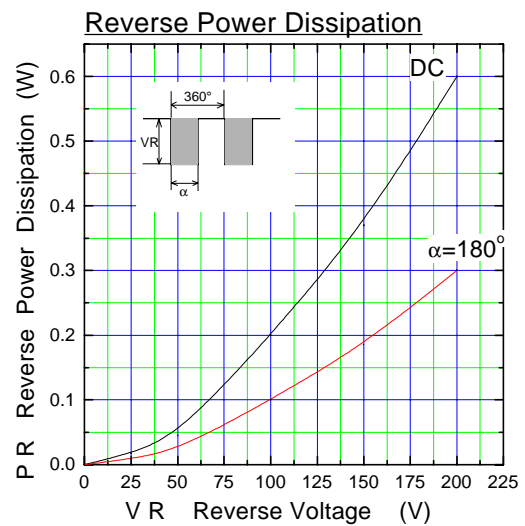
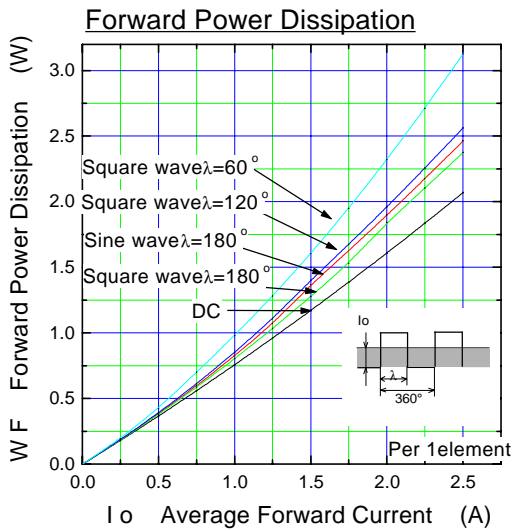
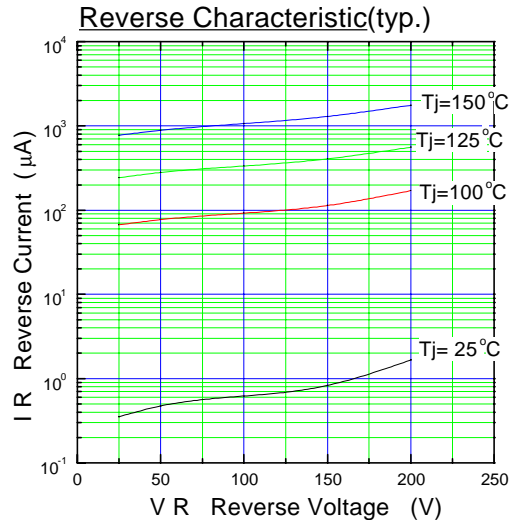
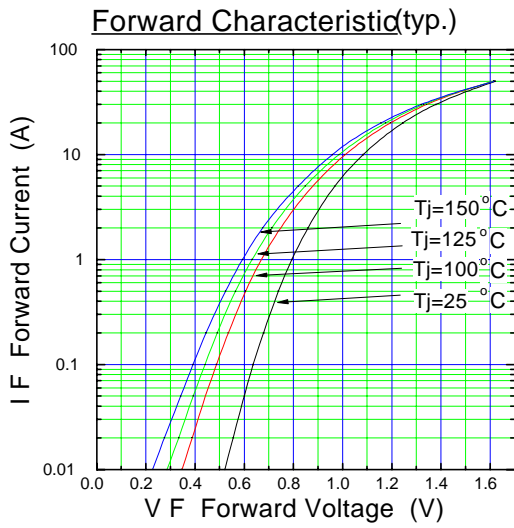

λ: Conduction angle of forward current for each rectifier element
I_o: Output current of center-tap full wave connection

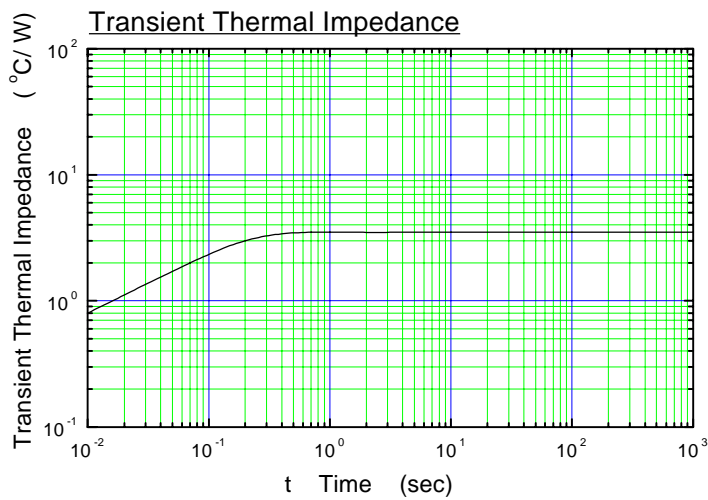
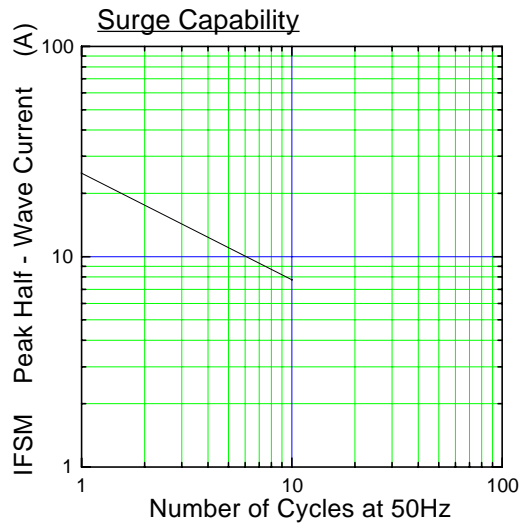

DERATING

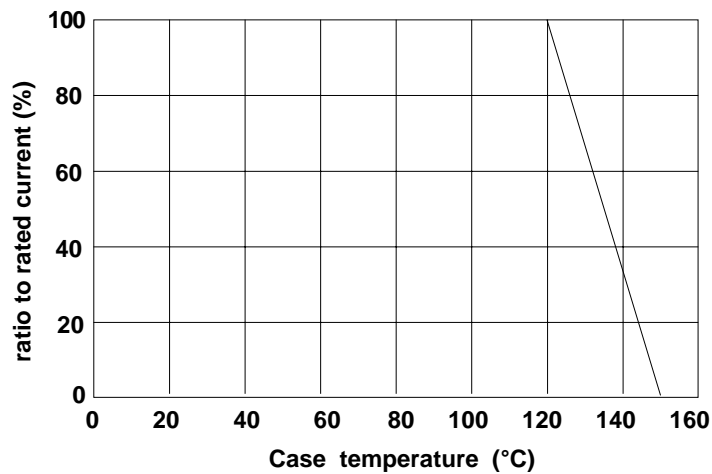

This datasheet has been download from:

www.datasheetcatalog.com

Datasheets for electronics components.